

PAPER TOWEL DISPENSER WP165



326 x 173 x 164 mm

approx. 250 paper towels

- Paper towel dispenser in robust, germ-reducing and easy-care stainless steel (AISI 304).
- All-stainless steel housing; all corners fully welded, visible surfaces satin finished and brushed. Further available surfaces: see below.
- With deep-drawn paper removal opening for easy paper removal.
- Designed for approx. 250 standard paper towels in zigzag- or c-fold. Paper size (folded): 240-250 mm x 100-115 mm.
- Accessible for refilling through lockable front flap.
- Keyed alike cylinder lock in corrosion-resistant zinc die-casting.
- Wear parts can be replaced as modules.
- Installation dimensions: 300 x 150 mm
- Mounting: With four screws on the inside, sideways.
- Delivery includes fixing material and one pack of paper towels.
- Weight, including single package: 3.4 kg



Suggested text for specifications:

Paper towel dispenser in stainless steel (AISI 304) for horizontal under-counter mounting.. All-stainless steel housing; all corners fully welded, visible surfaces satin finished and brushed. With deep-drawn paper removal opening, filling quantity approx. 250 paper towels. Accessible for refilling through lockable front flap. Keyed alike cylinder lock in corrosion-resistant zinc die-casting. Delivery includes fixing material and one pack of paper towels.

Dimensions: 326 x 173 x 164 mm

Article No. WP165

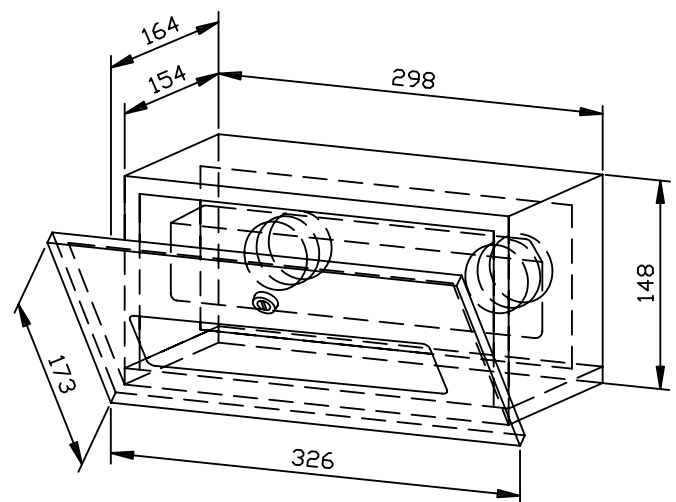

Available surfaces	ID No.
satin finished (standard)	764 186
highly polished	731 186
(coloured) plastic powder-coating	728 114

Ernst Wagner GmbH & Co. KG

Ernst-Abbe-Straße 21 · D-72770 Reutlingen · Tel.: +49712151539-0 · Fax: -20
info@wagner-ewar.de · www.wagner-ewar.de

WAGNER
EWAR